

# STANDARD ARRANGEMENTS

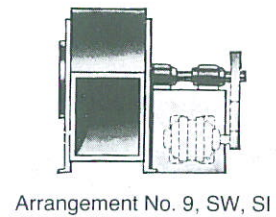

## DESIGNATION

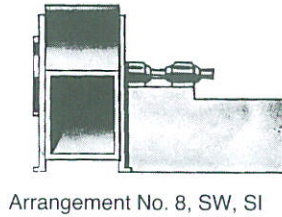
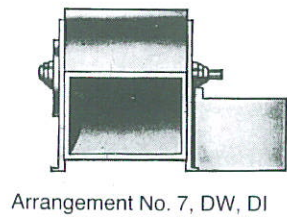
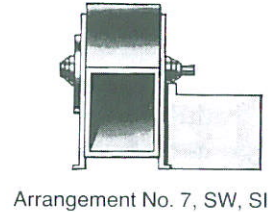
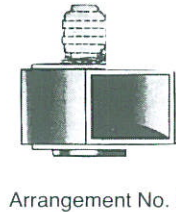
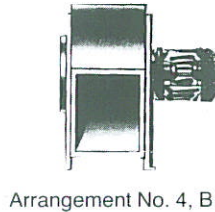
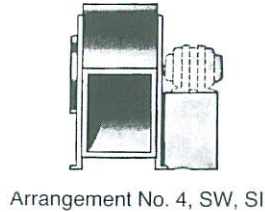
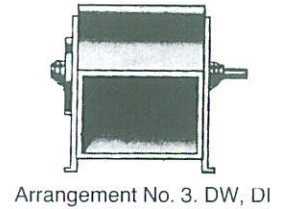
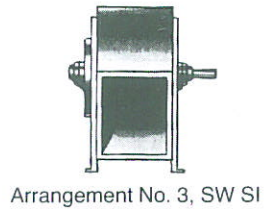
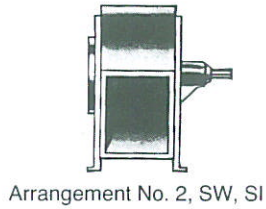
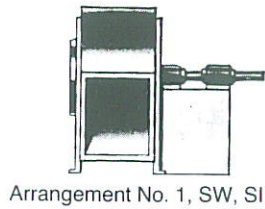
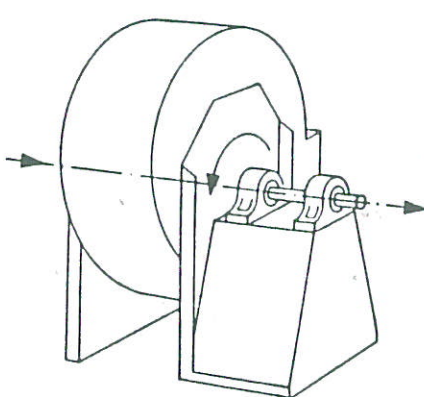
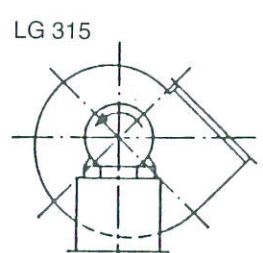
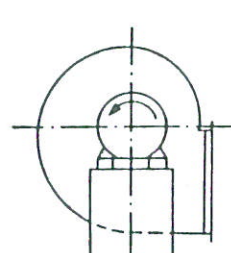
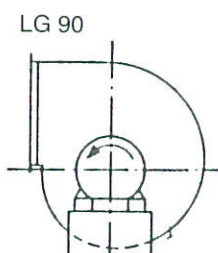
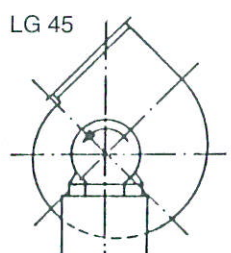
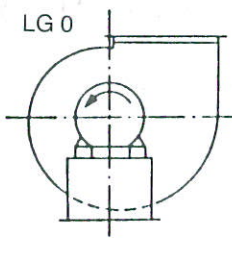
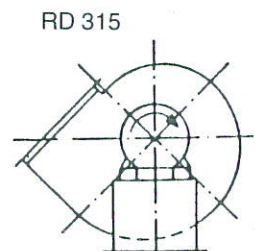
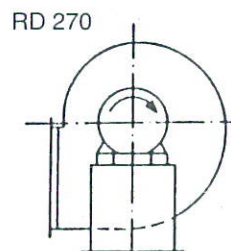
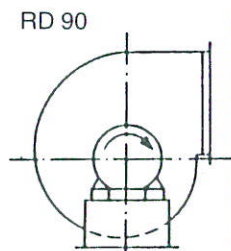
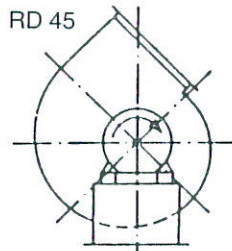
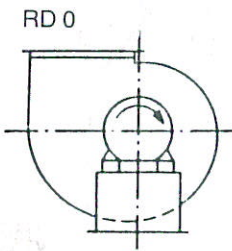

LG counter-clockwise rotation

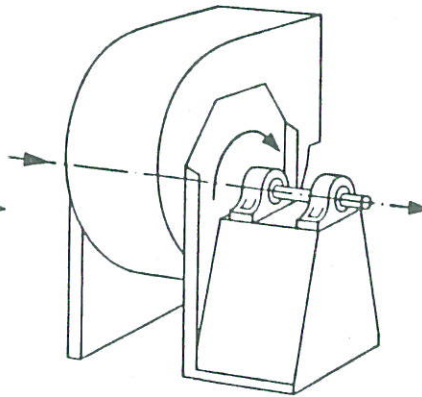

RD clockwise rotation

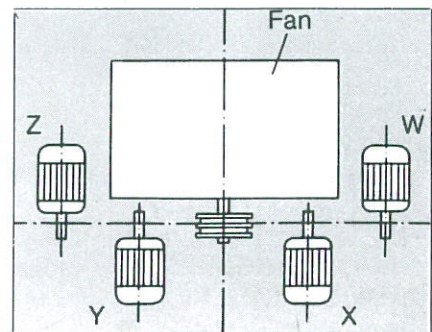

Method of designation of the alternative positions in plan view of a motor for belt or chain drive. Positions W and Z are standard, positions X and Y are only available to special order.